

Le Husky

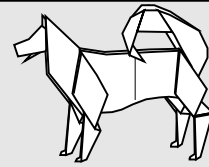

Modèle et Diagramme :
Christophe Boudias ;-)

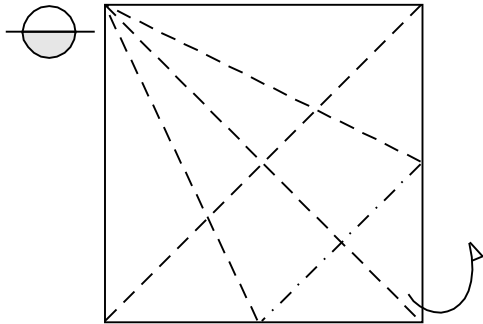

① Marquer les plis, plier derrière.

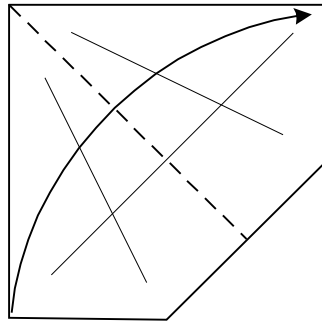

② Plier.

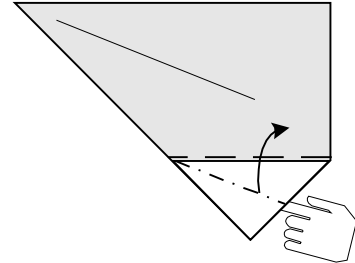

③ Pli aplati.

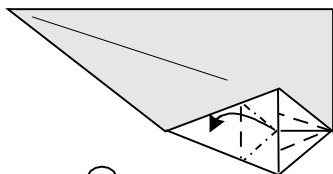

④ Pli pétale.

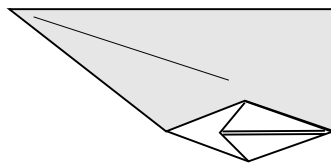

⑤ Déplier complètement.

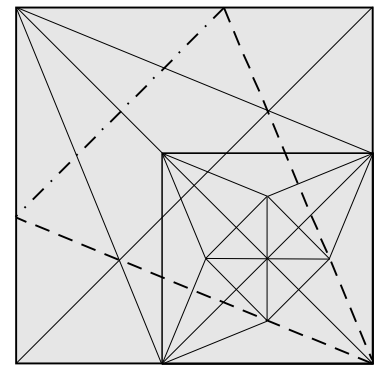

⑥ Répéter les étapes ① à ⑤ symétriquement.

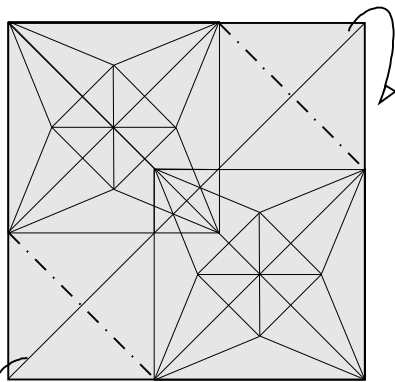

⑦ Plier derrière.

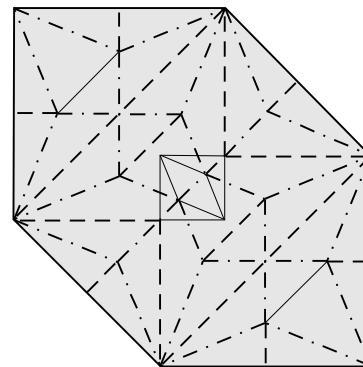

⑧ Plier...

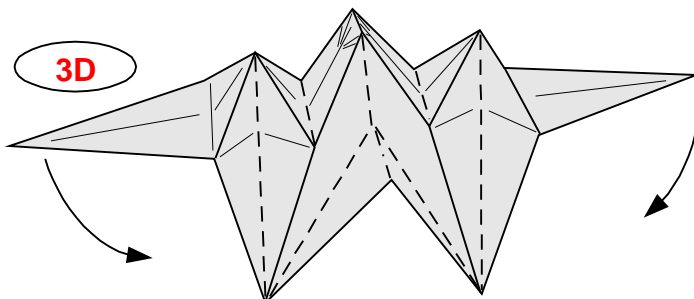

⑨ Etape intermédiaire.

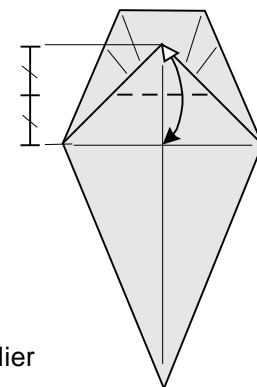

⑩ Plier, déplier

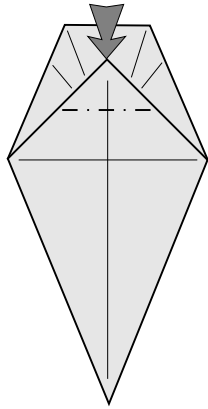

11 Sink

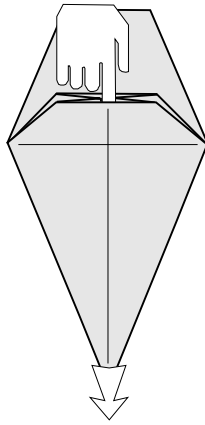

12 Pli étiré

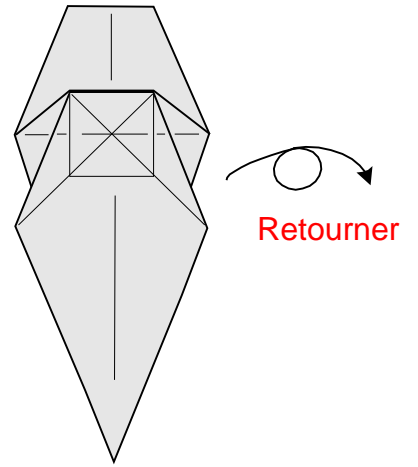

13 Résultat.

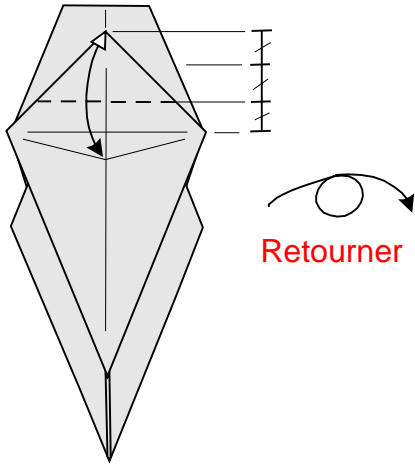

14 Plier, déplier, répéter les étapes 11 et 12

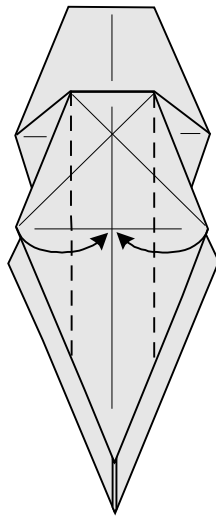

15 Plis vallés.

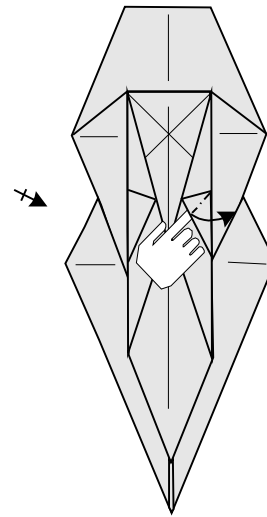

16 Pivoter vers l'extérieur.

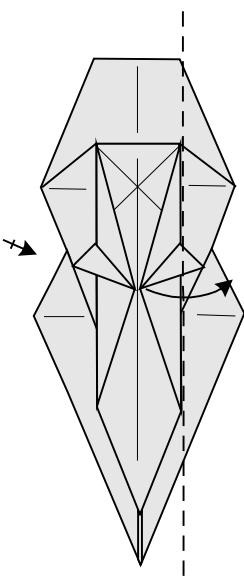

17 Plis vallés.

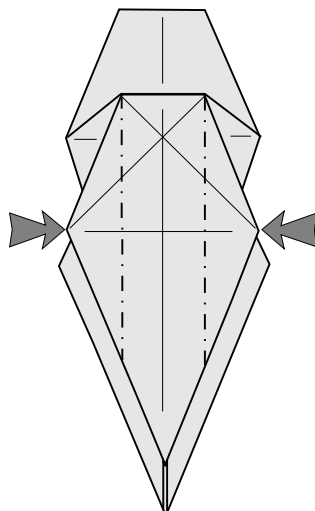

18 Closed Sink.

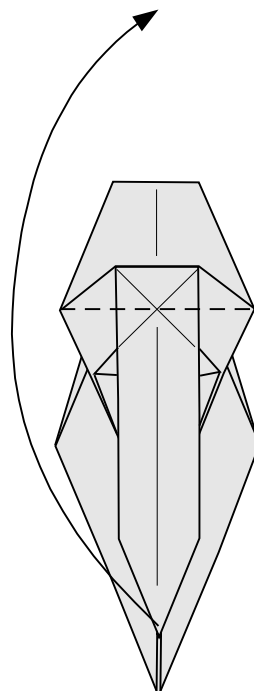

19 Pli vallé.

Pivoter
180°

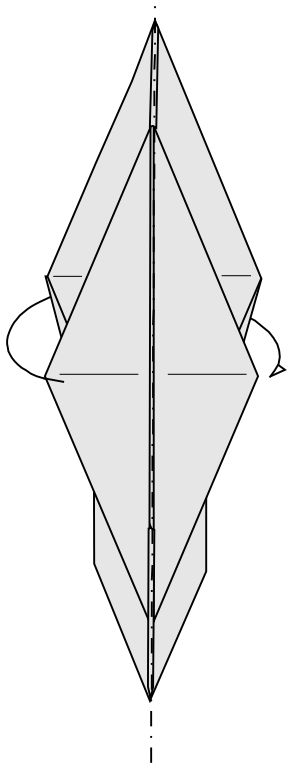

20 Plier en deux, par un pli montagne.

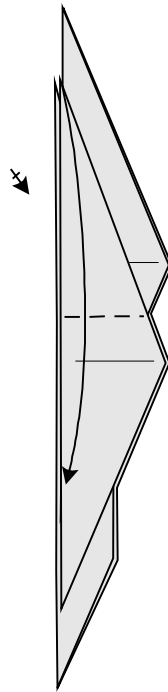

21 Plier vers le bas les pattes avants.

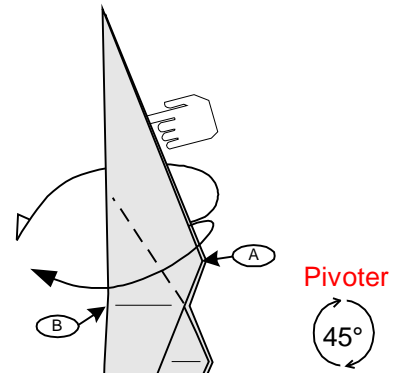

22 Pli inversé extérieur pour joindre A vers B.

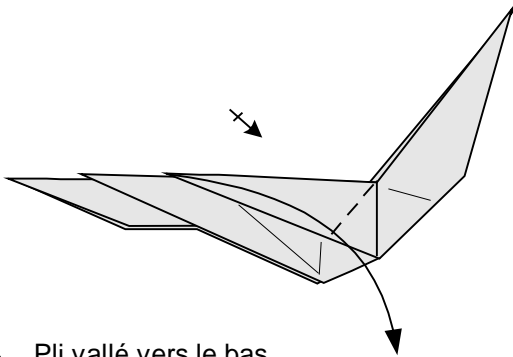

23 Pli vallé vers le bas pour les pattes avants.

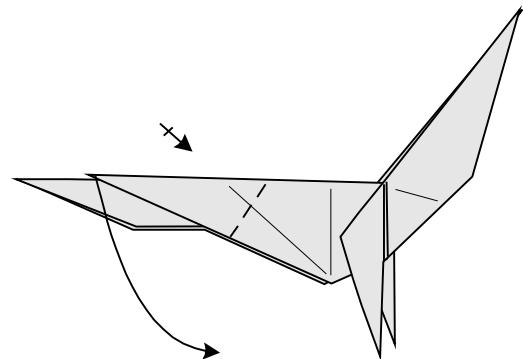

24 Pli vallé vers le bas pour les pattes arrières.

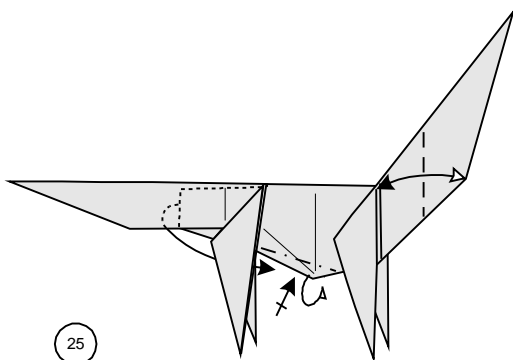

25 Rentrer le ventre, pli inversé intérieur pour le sexe du chien, marquer un pli pour la tête.

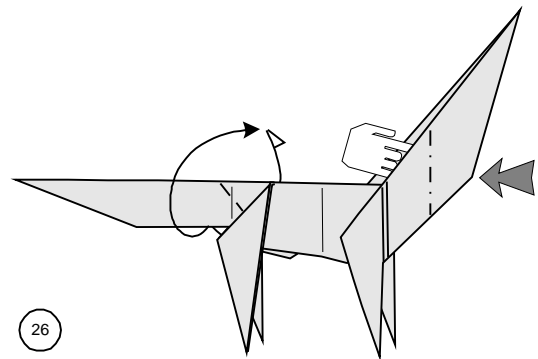

26 Pli inversé extérieur pour la queue.

Sink pour la tête.

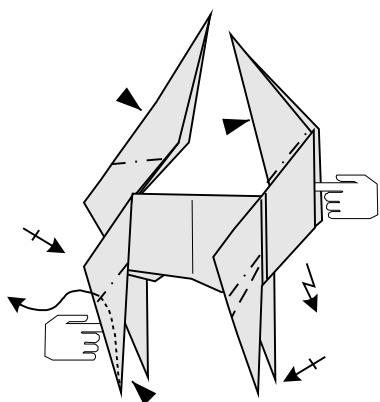

27 Plis inversés intérieurs pour la queue, la tête et les pattes arrières, pli zig-zag pour les pattes avants.

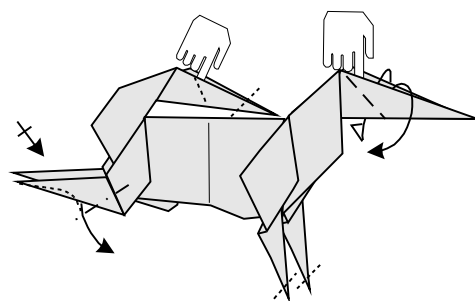

28 Plis inversés intérieurs pour les pattes arrières, plis inversés extérieurs pour la tête et la queue, repli pour les pattes avants.

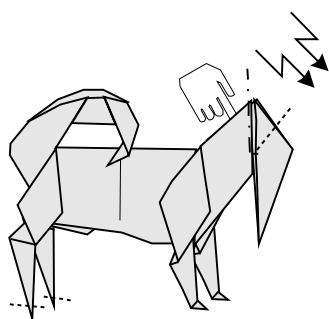

29 Pli zig-zag pour la tête, repli pour les pattes arrières.

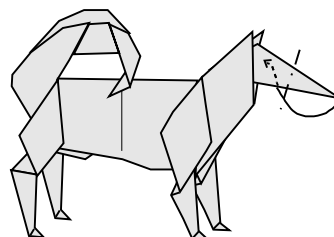

30 Rentrer.

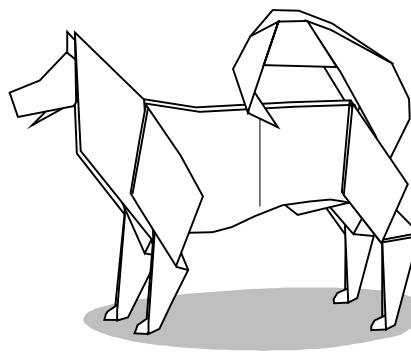
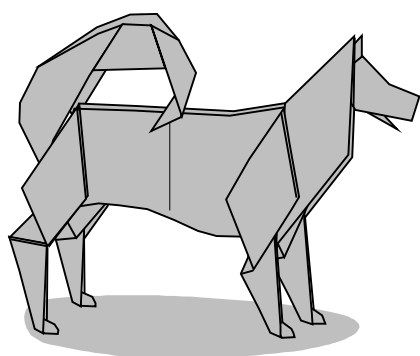

31 **Le Husky est terminé !**

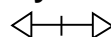

Infos:
Format de départ 21x21cm
Modèle terminé 4x7.5cm